

LIVING DISTRICT

Collection: OWEN

Installation manual for:











LD5023W8 W7.9"E3.9"H5.9"L1

Installation instructions:

1. Black wire from wall(junction box) attaches to "L" wire from the fixture.
2. White wire from wall(junction box) attaches to "N" wire from the fixture.
3. "E" wire from the fixture is attached to the mounting bracket and an additional "E" wire from the mounting bracket must be secured to the junction box.
4. Secure mounting bracket to the junction box.
5. Insert screws (P2) in side of top unit the mounting bracket.
6. Fix the Mounting bracket(P1) to the Canopy and tighten by the finial(P8).
7. Hanging crystal string (A) to metal lampshade(P9).
8. Use the screw (P10) to fix the metal lampshade(P9) into back plate.
9. Install the bulbs(not included) into the lamp fixture.

The end!

PARTS LIST

part	picture	Description	Qty	Check list
P1		D4" Mounting bracket	1	
P2		5/32-32 Screw	2	
P3		Power Cord 10" 18#	1	
P4		L7.5W5.3H0.6" Back Plate	1	
P5		lamp arm	1	
P6		D0.9"H1.6" metal lampcap	1	
P7		G9 lampholder	1	
P8		finial	2	
P9		W7.9"E3.9"H5.9" metal lampshade	1	
P10		Screw	2	
A		Crystal	10	

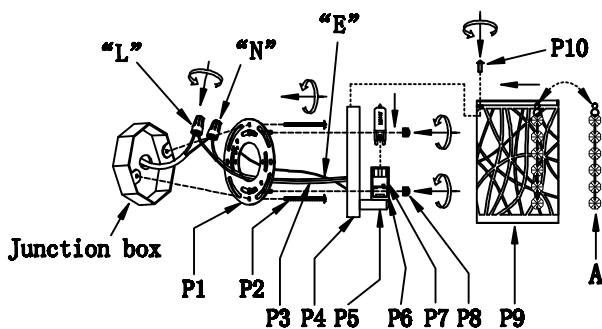

"L" = Hot wire
 "N" = Neutral wire
 "E" = Ground wire